

Cabinets and accessories for power supply



braun teleCom products have stood for competence and continuity for more than 35 years. Extensive experience and constantly growing know-how make the components and systems an integral part of many FTTH and HFC broadband networks.

While, in many areas, our activities focus on the development and production of our own products, we also serve as distributor for selected high-performance partners to achieve best possible customer satisfaction.

braun teleCom is a product brand of Netceed. We are a global leader in distribution, logistics, technical engineering, and product design with over 30 years of expertise and performance supporting the telecommunications and broadband industry.

Netceed is a global leader in distribution, logistics, technical engineering, and product design supporting the telecommunications and broadband industry. We supply and distribute a comprehensive range of passive and active equipment and tooling for network deployment, upgrades, and maintenance, supporting all technologies including FTTH, FTTx, HFC, Wi-Fi, 5G/mobile, and data center.

Netceed's comprehensive portfolio of 90,000+ products from nearly 1,500 industry-leading suppliers, along with their value-added supply chain solutions support carriers' seamless delivery of high-speed Internet, Video, Data, and Voice services to Residential, Business, and Mobile Users.



CONTENT

1. COAXIAL TECHNOLOGY

2. CABINETS AND ACCESSORIES FOR POWER SUPPLY

Cabinets	3
<i>Outdoor cabinets</i>	<i>4</i>
<i>Indoor cabinets</i>	<i>6</i>
Accessories for power supply	7
<i>230 V power sockets and cords</i>	<i>8</i>
<i>MSK remote power supplies</i>	<i>9</i>
<i>Remote power supplies with 48 VAC sec.</i>	<i>10</i>
<i>Remote power supplies with 65 VAC sec.</i>	<i>11</i>
Grounding material	13

3. OPTICAL SYSTEMS

4. TOOLS

5. CLICK & GO

6. AUTHORIZED DISTRIBUTION

CABINETS

Do you have questions concerning our products or want to place an order?

We look forward to your call!
+49 511 757086

Do you already know, which products you need?
shop.brauntelecom.com

Outdoor cabinets

Outdoor cabinets – solid and safe

Our cabinets,

... developed in close cooperation with our customers and manufacturers, have been installed in the cold environment of Iceland as well as in the heat of Saudi Arabia over the years. The cabinets are robust and have a long product life. In terms of insulation and ventilation, they are designed to withstand European climatic conditions. All cabinets are manufactured in conformity with ISO 9001 standards.



- Application**
- Trunk or distribution amplifier cabinet
- Design**
- Removable front cover with cylinder lock for easy installation
- Material**
- Base material: Galvanized, hot-dip refined steel plate, 1,5 mm
 - Increased corrosion resistance by phosphatization, chromate coating and 80 µm polyester powder coating of the surface

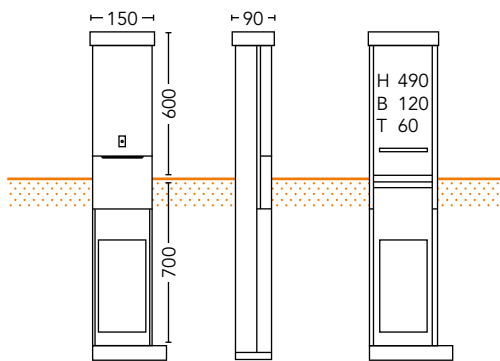

← Cabinet 20-SA-1-MP

Order No. 75320000

Mounting-Dimensions (H x B x T) [mm]: 490 x 120 x 60
Lock: Triangular lock

Accessories	Description	Order No.
Triangular key	for cabinets 20-SA-1MP, 35-SA-7R and 35-SA-10R	75290000
Mounting plate	Wood, metal plated	75341000

Cabinet 35-SA-2-R →

Order No. 75000000

Mounting-Dimensions (H x B x T) [mm]: 490 x 250 x 90
Lock: RUKO cylinder lock

Accessories	Description	Order No.
RUKO key	for cabinets 35-SA-xx	75400100
Mounting plate	Wood, metal plated	75021000

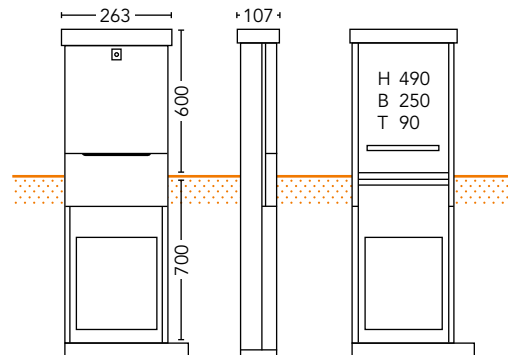

← Cabinet 35-SA-2,5-R

Order No. 75080000

Mounting-Dimensions (H x B x T) [mm]: 600 x 280 x 150
Lock: RUKO cylinder lock

Accessories	Description	Order No.
RUKO key	for cabinets 35-SA-xx	75400100
Mounting plate	Wood, metal plated	75101000

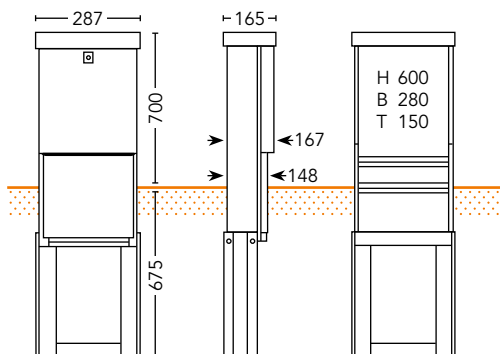

Cabinet 35-SA-3-R →

Order No. 75120000

Mounting-Dimensions (H x B x T) [mm]: 600 x 340 x 158
 Lock: RUKO cylinder lock

Accessories	Description	Order No.
RUKO key	for cabinets 35-SA-xx	75400100
Mounting plate	Wood, metal plated	75141000

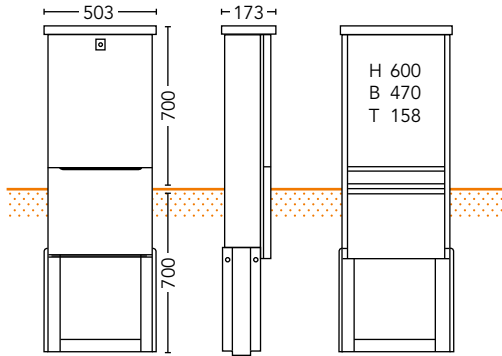
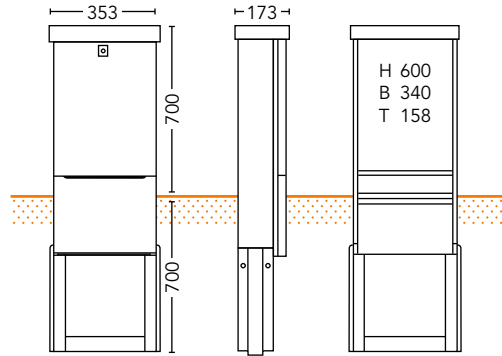

← Cabinet 35-SA-4-R

Order No. 75160000

Mounting-Dimensions (H x B x T) [mm]: 600 x 470 x 158
 Lock: RUKO cylinder lock

Accessories	Description	Order No.
RUKO key	for cabinets 35-SA-xx	75400100
Mounting plate	Wood, metal plated	75181000

Cabinet 35-SA-6-R →

Order No. 75200000

Mounting-Dimensions (H x B x T) [mm]: 600 x 540 x 198
 Lock: RUKO cylinder lock

Accessories	Description	Order No.
RUKO key	for cabinets 35-SA-xx	75400100
Mounting plate	Wood, metal plated	75221000

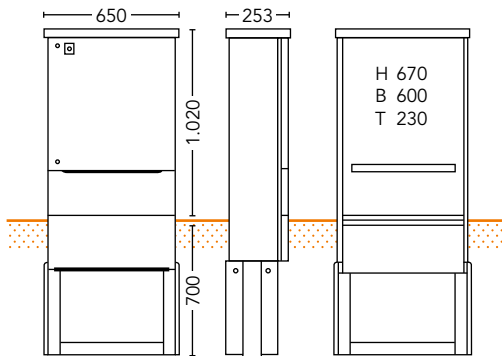
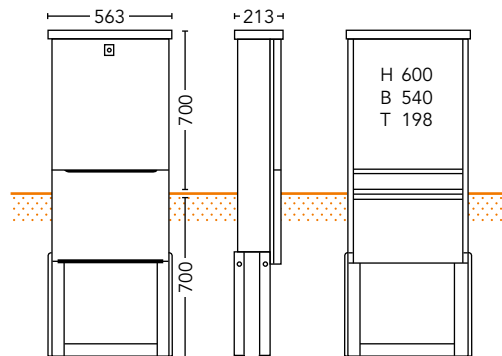

← Cabinet 35-SA-7-R

Order No. 75240000

Mounting-Dimensions (H x B x T) [mm]: 670 x 600 x 230
 Lock: RUKO cylinder lock and triangular lock

Accessories	Description	Order No.
RUKO key	for cabinets 35-SA-xx	75400100
Triangular key	for cabinets 20-SA-1MP, 35-SA-7R and 35-SA-10R	75290000
Mounting plate	Wood, metal plated	75261000

Cabinet 35-SA-10-R →

Order No. 75280000

Mounting-Dimensions (H x B x T) [mm]: 670 x 1.050 x 230
 Lock: RUKO cylinder lock and triangular lock

Accessories	Description	Order No.
RUKO key	for cabinets 35-SA-xx	75400100
Triangular key	for cabinets 20-SA-1MP, 35-SA-7R and 35-SA-10R	75290000
Mounting plate	Wood, metal plated	75301000

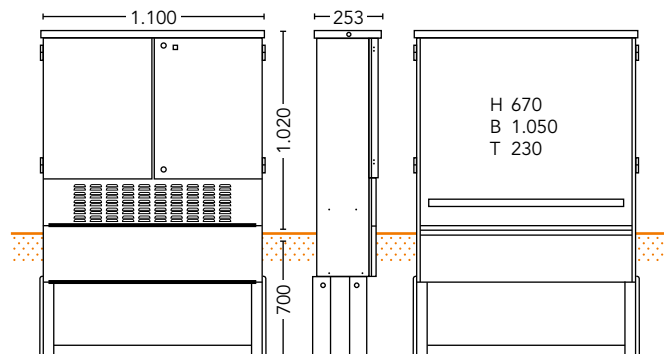

Indoor cabinets

with 4-point locking



74908934
IS-34-LB

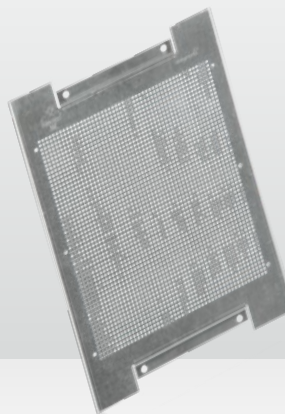

74993405
Mounting plate

- Steel plated box, 1,2 mm steel plate
- Powder coating grey RAL 7035 (non-peeling, lead and cadmium free)
- Locking with 3 latches turned by 1 lock (basquill lock) and a removable door with Z-profile as 4th latch
- Baton locking system for high safety against burglary must be ordered separately
- 1 uncoated grounding connection is provided in the cabinet and on the door
- Including covers for the openings of the cable gland, 1 sticker "Warning of electrical voltage" and 1 grounding cable 2,5 m
- The cabinets are delivered with fitting IS-xx-perforated-metal-plates with grounding
- Space for cable entrance and exit at the top and the bottom of the housing (100 x 40 mm)
- When using the braun teleCom locking system, the corresponding keys must be ordered separately
- The installation of a customized Baton locking system or an exclusive Baton locking system are of course available on request

Item	Description	Order No.
IS-34-LB	400 x 300 x 200 mm with perforated metal mounting plate, without lock	74908934
IS-44-LB	400 x 400 x 200 mm with perforated metal mounting plate, without lock	74908944
IS-4420-LB	400 x 400 x 200 mm with rear wall, perforated metal mounting plate and hinges, without lock	74914420
IS-63-LB	600 x 400 x 200 mm with perforated metal mounting plate, without lock	74908963
IS-6420-LB	600 x 400 x 200 mm with rear wall, perforated metal mounting plate and hinges, without lock	74916420
IS-66-LB	600 x 600 x 200 mm with perforated metal mounting plate, without lock	74908966
IS-83-LB	800 x 600 x 200 mm with perforated metal mounting plate, without lock	74908983
IS-84-LB	600 x 800 x 250 mm with perforated metal mounting plate, without lock	74908984
IS-8625-LB	800 x 600 x 250 mm with rear wall, perforated metal mounting plate and hinges, without lock	74918625
IS-86-LB	800 x 600 x 320 mm with perforated metal mounting plate, without lock	74908986
IS-88-LB	800 x 800 x 250 mm with perforated metal mounting plate, without lock	74908988
IS-104-LB	1.000 x 800 x 250 mm with perforated metal mounting plate, without lock	74908999
IS-106-LB	1.200 x 800 x 320 mm with perforated metal mounting plate, without lock	74909000

Perforated metal mounting plates

Item	Description	Order No.
Mounting plate	Perforated metal mounting plate for IS-34	74993404
Mounting plate	Perforated metal mounting plate for IS-44	74994404
Mounting plate	Perforated metal mounting plate for IS-63	74996404
Mounting plate	Perforated metal mounting plate for IS-66	74996604
Mounting plate	Perforated metal mounting plate for IS-83	74998404
Mounting plate	Perforated metal mounting plate for IS-88	74998804
Mounting plate	Perforated metal mounting plate for IS-104	74999004

Accessories

Item	Description	Order No.
Baton-Lock-03	Baton lock type 6, closure 03, Unitymedia and VF/KDG locking system	71590003
Baton-Lock-30	Baton lock type 6, closure 30, braun teleCom locking system	71590030
Baton-Lock-HSSL	Baton lock type 6, closure HSSL, VF/KDG nationwide (Germany) locking system	71590054
Key	For braun teleCom locking system 30	71580030
Cover plate	For sealing the cable entry	74908905
Sticker	Lightning – Warning of electrical voltage	43020251
Replacement grounding accessories		70000200

We do not have the perfect indoor cabinet or locking system in our product portfolio yet?

We are happy to provide further cabinet sizes and individual locking systems on request!

ACCESSORIES FOR POWER SUPPLY

Do you have questions concerning our products or want to place an order?

We look forward to your call!
+49 511 757086

Do you already know, which products you need?
shop.brauntelecom.com

230 V power sockets and cords

45410100
Dual power socket



45410101
Dual power socket



45199999
Electrical power cord



Surface-mounted power sockets

Item	Description	Order No.
Single power socket	Surface-mounted single power socket IP44, grey, approx. 70 x 70 x 48 mm (W x H x D), halogen free	45400151
Dual power socket	Surface-mounted dual power socket IP44, grey, horizontal, approx. 130 x 70 x 48 mm (W x H x D), halogen free	45410101
Dual power socket	Surface-mounted dual power socket IP44, grey, horizontal, approx. 93 x 79 x 50 mm (W x H x D), clamp connection, manufacturer: Pollmann	45410102
Dual power socket	Surface-mounted dual power socket IP44, grey, vertical, approx. 70 x 130 x 48 mm (W x H x D), halogen free	45410105
Dual power socket	Surface-mounted dual power socket IP44, grey, horizontal, approx. 92 x 75 x 55 mm (W x H x D), screwing connection, manufacturer: Kopp	45410100

Electrical power cords

Item	Description	Order No.
Electrical power cord	PVC NYM-J 3x1,5, 50 m	45199999
Electrical power cord	PVC NYM-J 3x1,5, 100 m	45200000

MSK remote power supplies

with 65 VAC sek.



10491030
MSK-865-S

- Plastic encapsulated safety stray field transformer with magnetic voltage stabilisation
- Clamp connection with 2 x PG cable entries
- Short circuit current limiter
- Produced according to VDE 0550/3
- Available as trapezoidal or sinus constant source (T/S)
- Full resin encapsulated

Parameter	MSK-665-T	MSK-665-S	MSK-865-S	MSK-1065-S
Primary mains voltage [VAC]	230 (50 Hz -20 ... +10 %)	230 (50 Hz -20 ... +10 %)	230 (50 Hz -20 ... +10 %)	230 (50 Hz -20 ... +10 %)
Secondary voltage [VAC]	65 Trapezoid	65 Sinus	65 Sinus	65 Sinus
Primary fuse	external 16 A Tr.	external 16 A Tr.	external 16 A Tr.	external 16 A Tr.
Short circuit current limiter secondary	1,6 times I_{nominal}	1,6 times I_{nominal}	1,6 times I_{nominal}	1,6 times I_{nominal}
Load output [VA]	422,5 (max. 5A/65 V)	390 (max. 6,5 A/65 V)	520 (max. 9 A/65 V)	650 (max. 10 A/65 V)
Test Voltage [kV]	2,7	2,7	2,7	2,7
Transient time [ms]	20 ... 40	20 ... 40	20 ... 40	20 ... 40
Safety class	Class II	Class II	Class II	Class II
Insulation class	T 40/B	T 40/B	T 40/B	T 40/B
Ambient temperature max. [°C]	-25 ... +55	-25 ... +55	-25 ... +55	-25 ... +55
Efficiency	85-89 %	85 %	85 %	85 %
Weight [kg]	approx. 23	approx. 23	approx. 26	approx. 28
Dimensions (L x W x H) [mm]	330 x 202 x 180	330 x 202 x 180	330 x 202 x 180	330 x 202 x 180
Order No.	10491010	10491020	10491030	10491040

Remote power supplies with 48 VAC sec.



10490000
FN-04

- Plastic casing safety transformer with clamp connection
- Separately windings – double isolation
- Designed for industrial current supply
- Short circuit protected
- Production acc. to EN 60742 Class II (VDE 0551)
- Approved by DEMKO, NEMKO, SETI

Parameter	FN-01	FN-21	FN-23	FN-03	FN-04
Primary mains voltage [VAC]	N-230-250 (50 – 60 Hz)	N-230-250 (50 – 60 Hz)	N-230-250 (50 – 60 Hz)	N-230-250 (50 – 60 Hz)	N-230-250 (50 – 60 Hz)
Secondary voltage [VAC]	0-42-48	0-42-48	0-42-48	0-42-48	0-42-48
Primary fuse	–	0,8 AT	–	4 A	4 A
Secondary fuse	6,3 AT	–	2,5 AT	12 A Automat	–
Load output [VA]	240 (max. 5,7 A/42 V, 5 A/48 V)	60 (max. 1,4 A/42 V, 1,25 A/48 V)	120 (max. 2,85 A/42 V, 2,5 A/48 V)	420 (max. 10 A/42 V, 8,75 A/48 V)	580 (max. 12 A/48 V)
Test voltage [kV]	4	4	4	4	4
Safety class (EN 60742)	Class II double isolated	Class II double isolated	Class II double isolated	Class II double isolated	Class II double isolated
Isolation class	B (130°)	B (130°)	B (130°)	B (130°)	B (130°)
Ambient temperature max. [°C]	-10 ... +50	-10 ... +50	-10 ... +50	-10 ... +50	-10 ... +50
Overcharging protection	TCO Fuse 152° prim.	TCO Fuse 152° prim.	TCO Fuse 152° prim.	TCO Fuse 152° prim.	TCO Fuse 152° prim.
Protection class	IP 44	IP 44	IP 44	IP 44	IP 44
Weight [kg]	4,1	1,3	2,5	7,7	7,7
Dimensions (L x W x H) [mm]	152 x 105 x 93	113 x 73 x 61	131 x 91 x 81	200 x 130 x 115	200 x 130 x 115
Order No.	10460000	10460200	10460300	10480000	10490000

Remote power supplies with 65 VAC sec.



10490500
FN-14

- Plastic casing safety transformer with clamp connection
- Separately windings – double isolation
- Designed for industrial current supply
- Short circuit protected
- Production acc. to EN 61558-2-41 (VDE 0551)
- Approved by DEMKO, NEMKO, SET1
- For ambient temperatures up to +55°C

Parameter	FN-11	FN-13	FN-14
Primary mains voltage [VAC]	N-230-250 (50 – 60 Hz)	N-230-250 (50 – 60 Hz)	N-230-250 (50 – 60 Hz)
Secondary voltage [VAC]	0-65	0-65	0-65
Primary fuse	3,15 AT	4 A	6,3 A
Secondary fuse	5 A Automat	8 A Automat	10 A Automat
Load output [VA]	325 (max. 5 A/65 V)	520 (max. 8 A/65 V)	650 (max. 10 A/65 V)
Test voltage [kV]	4	4	4
Safety class (EN 60742)	Class II double isolated	Class II double isolated	Class II double isolated
Isolation class	B (130°)	B (130°)	B (130°)
Ambient temperature max. [°C]	-10 ... +50	-10 ... +50	-10 ... +50
Overcharging protection	TCO Fuse 152° prim.	TCO Fuse 152° prim.	TCO Fuse 152° prim.
Protection class	IP 44	IP 44	IP 44
Weight [kg]	6,7	7,9	12,5
Dimensions (L x W x H) [mm]	200 x 130 x 115	200 x 130 x 115	235 x 162 x 140
Order No.	10460500	10480500	10490500

GROUNDING MATERIAL

Do you have questions concerning our products or want to place an order?

We look forward to your call!
+49 511 757086

Do you already know, which products you need?
shop.brauntelecom.com

Grounding material

41011505
Potential equalization bar



45100060
Ground cable



Grounding strap clamps

Item	Description	Order No.
Grounding strap clamp	1/8 – 4", length 38,5 cm	41010000
Grounding strap clamp	1/8 – 1 1/2", length 17 cm	41010100
Grounding strap clamp	1/8 – 3/8", length 11 cm	41010101

Ground cable

Item	Description	Order No.
Ground cable	Cable H07 V-K 1 x 4 mm ² QMM (flexible) green/yellow	45100041
Ground cable	Cable H07 V-U 1 x 4 mm ² QMM (solid) green/yellow	45100040
Ground cable	Cable H07 V-U 1 x 6 mm ² QMM (solid) green/yellow	45100060
Ground cable	Cable H07 V-U 1 x 10 mm ² QMM (solid) green/yellow	45100100

Potential equalization bars

Item	Description	Order No.
Potential equalization bar, small	For local potential equalization, 1 x 6 – 25 mm ² , 5 x 1,5 – 6 mm ² , cover PP, halogen-free	41011500
Potential equalization bar, large	For local potential equalization, connection for 1 x tape clamp 30 x 40 mm or 8 circular conductors 10 mm, 1 x circular conductor 6 – 50 mm ² and 7 x circular conductors 2,5 – 25 mm ² with double row screwing, cover PP, halogen-free	41011505

Ring terminal lugs

Item	Description	Order No.
Insulated ring terminal lug	Insulated ring terminal lug, for wire range 2,5 – 6,0 mm ² , yellow	45300042
Insulated ring terminal lug	Insulated ring terminal lug, for wire range 2,5 – 6,0 mm ² , yellow	45300043

42090600

Grounding block 6-way HQ



42090800

Grounding block 8-way HQ



GND wire

Item	Description	Order No.
GND wire 2,0 m Cu	Ground wire for double galvanic isolated wall outlets or boxes btv 1 IEC-NL; btv 1 F-NL; btv-DGIB-1; btv-DGIB-2, colour: green/yellow, 2,5 mm ² Cu-core 14AWG (51/0,254 stranded cable) – one end with insulated ring terminal, 2nd end tinned	24100720

Mounting brackets

Item	Description	Order No.
Mounting bracket	6-way for connectors PG 11 chassis, connection of 6 connectors with PG 11 chassis and 1 ground wire, dimensions 261 x 64 x 44 mm	44000000
Mounting bracket	3-way for connectors PG 11 chassis, connection of 3 connectors with PG 11 chassis and 1 ground wire, dimensions 131 x 64 x 44 mm	44030000

Grounding blocks HQ professional

- All F-female connectors are equipped with high-quality F-18-HQ-1 cable splices (gold plated pin and specially designed dielectric inserts)
- Screening ≥ 96 dB
- All grounding blocks:
Insertion loss $\leq 0,1$ dB at 1.000 MHz
Return loss > 30 dB at 1.000 MHz.

Item	Specification	Amount of connections	F-female	Dimensions [mm]	Order No.
Grounding block	1-way HQ	1 x coax, 1 x ground wire	single row	44 x 26 x 26,5	42070000
Grounding block	2-way HQ	2 x coax, 1 x ground wire	single row	68 x 26 x 26,5	42080000
Grounding block	4-way HQ	4 x coax, 1 x ground wire	double row	70 x 50 x 40	42090400
Grounding block	6-way HQ	6 x coax, 1 x ground wire	double row	82 x 50 x 40	42090600
Grounding block	8-way HQ	8 x coax, 1 x ground wire	double row	105 x 50 x 40	42090800
Grounding block	10-way HQ	10 x coax, 1 x ground wire	double row	137 x 50 x 40	42150000
Grounding block	11-way HQ	11 x coax, 1 x ground wire	double row	137 x 50 x 40	42151100
Grounding block	13-way HQ	13 x coax, 1 x ground wire	double row	160 x 50 x 40	42151300
Grounding block	14-way HQ	14 x coax, 1 x ground wire	double row	170 x 50 x 40	42151400
Grounding block	17-way HQ	17 x coax, 1 x ground wire	double row	203 x 50 x 40	42151700
Grounding block	25-way HQ	25 x coax, 1 x ground wire	triple row	217 x 70 x 40	42152500
Grounding block	28-way HQ	28 x coax, 1 x ground wire	triple row	240 x 70 x 40	42152800

Do you have questions concerning our products or want to place an order?

We look forward to your call!
+49 511 757086

Do you already know, which products you need?
shop.brauntelecom.com



